



CRM-111H CRM-113H

Multi-function time relay



Characteristic

- Multi-function time relay for universal use in automation, control and regulation or in house installations.
- All functions initiated by the supply voltage, except for the flasher function, can use the control input to inhibit the delay (pause).
- Relay mode selection - according to the set function, permanently closed, permanently open, function of memory latch with delay (CRM-111H) / switching of the second relay according to supply voltage (CRM-113H).
- Universal supply voltage AC/DC 12 – 240 V.
- Time scale 50 ms - 30 days divided into 10 ranges: (50 ms - 0.5 s / 0.1 s - 1 s / 1 s - 10 s / 0.1 min - 1 min / 1 min - 10 min / 0.1 hr - 1 hrs / 1 hrs - 10 hrs / 0.1 days - 1 day / 1 day - 10 days / 3 days - 30 days).
- Output contact:
 CRM-111H: 1x changeover / SPDT 16 A
 CRM-113H: 1x changeover / SPDT 16 A, 2x changeover / DPDT 8 A
- Multifunction red LED flashes or shines depending on the operating status.

Description

CRM-113H

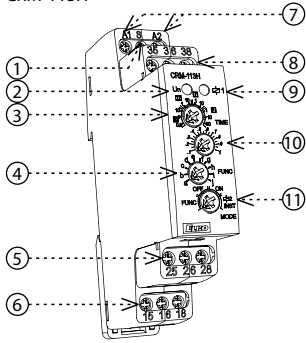

- Control input „S“
- Supply indication
- Time range setting
- Function setting
- Output contacts 2 (25-26-28)
- Output contacts 1 (15-16-18)
- Supply terminals
- Output contacts 3 (35-36-38)
- Output indication
- Fine time setting
- Relay mode selection

Connection

CRM-111H CRM-113H

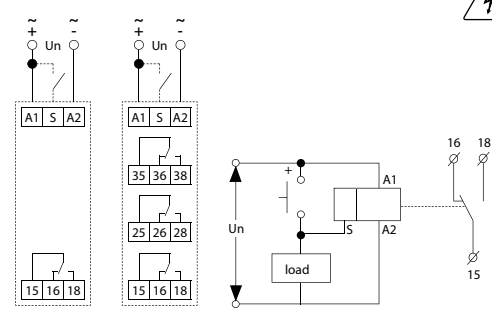

CRM-113H:
 The potential difference between the supply terminals (A1-A2), output contact 2 (25-26-28) and output contact 3 (35-36-38) must be a maximum of 250V AC rms / DC.

Possibility to connect load onto controlling input
 It is possible to connect the load (e.g.: contactor) between terminals S-A2, without any interruption of correct relay function.

Indication of operating states

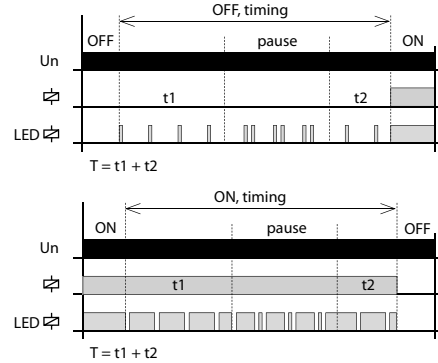

Relay mode selection

FUNC. SETTINGS FUNCTION MODE

The desired function a-j is set with the FUNC rotary switch.

OFF. RELAY OPEN MODE



ON. RELAY CLOSED MODE



k. Function: MEMORY LATCH with delay (Only for CRM-111H)



When the supply voltage is applied, the relay is open. If the control contact is closed, the relay closes and the time delay T starts. It does not matter the length of the control pulse. When the timing is complete, the relay opens. If the control contact is closed during timing, the relay opens immediately. Each time the control contact closes during relay timing, it changes status.

2 INST. SECOND RELAY INSTANTANEOUS (Only for CRM-113H)



The second relay switches according to the supply voltage. The first relay switches according to the function (a-j) set by the trimmer FUNC.

Functions

a. ON DELAY

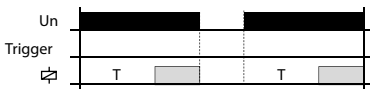

When the supply voltage is applied, the time delay T begins. When the timing is complete, the relay closes and this condition continues until the supply voltage is disconnected.

ON DELAY with Inhibit

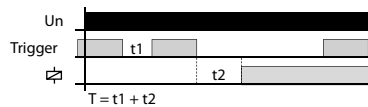

If the control contact is closed and the supply voltage is connected, the relay is opened and timing does not start until the control contact opens. When the timing is complete, the relay closes. If the control contact is closed during timing, the timing is interrupted and continues only after the control contact opens.

b. INTERVAL ON



After supply voltage relay closes and starts the delay time T. After the end of the timing relay opens and this state lasts until the supply voltage is disconnected.

INTERVAL ON with Inhibit

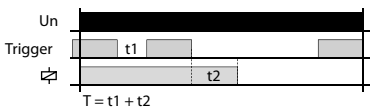

If the control contact is closed and the supply voltage is connected, the relay will close and the timing will start only after the control contact has been opened. When the timing is complete, the relay opens. If the control contact is closed during timing, the timing is interrupted and continues only after the control contact opens.

c. FLASHER - ON first



After supply voltage relay closes and starts the delay time T. After the end of the timing relay opens and again runs delay time T. When the timing is complete, the relay closes again and the sequence is repeated until the supply voltage is disconnected. If the control contact is closed during timing, this does not affect the operation of the cyclor.

FLASHER - OFF first

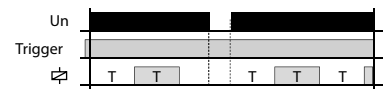

If the control contact is closed during timing; this does not affect the operation of the cyclor. If the control contact is closed and the supply voltage is connected, the cyclor starts with a pause (relay open).

d. MEMORY LATCH

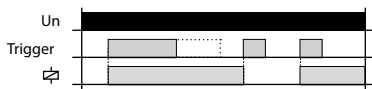

When the supply voltage is applied, the relay is open. When the control contact is closed, the relay closes. The status does not change when the control contact is opened. When the control contact is closed again, the relay opens. Each time the control contact is closed, the relay changes status.

e. OFF DELAY



When the supply voltage is applied, the relay is open. When the control contact is closed, the relay closes. When the control contact opens, the time delay T begins. If the control contact is closed during timing, the time is reset and the relay remains closed. When the control contact opens, the time delay T starts again and opens when the relay closes.

f. SINGLE SHOT



When the supply voltage is applied, the relay is open. When the control contact is closed, the relay closes and the time delay T begins. Closing the control contact during timing is ignored.

g. WATCHDOG



When the supply voltage is applied, the relay is open. When the control contact is closed, the relay closes and the time delay T begins. Closing the control contact during timing triggers a new time delay T - the relay closing time is thus increased.

h. PULSE GENERATOR 0.5s

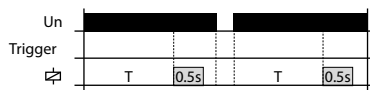

After the supply voltage has been applied, the time delay T begins. When the timing is complete, the relay closes for a fixed time (0.5s).

PULSE GENERATOR 0.5s with Inhibit

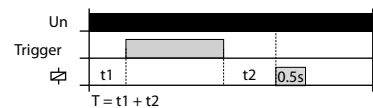

After supply voltage starts the time delay T. By closing timing of the control contact during timing is suspended. When the control contact opens, the time interval is completed and the relay closes for a fixed time (0.5s).

Technical parameters

CRM-111H CRM-113H

Power supply

Supply terminals:	A1 - A2	
Voltage range:	AC/DC 12 - 240 V (AC 50 - 60 Hz)	
Power input (max.):	2 VA / 1.5 W	2.5 VA / 1.5 W
Supply voltage tolerance:	-15 %; +10 %	
Supply indication:	green LED	

Time circuit

Number of functions:	11	10
Time ranges:	50 ms - 30 days	
Time setting:	rotary switches and potentiometers	
Time deviation*:	5 % - mechanical setting	
Repeat accuracy:	0.2 % - set value stability	
Temperature coefficient:	0.01 % / °C, at = 20 °C (0.01 % / °F, at = 68 °F)	

Output

Number of contacts 1:	1x changeover / SPDT (AgNi)	
Current rating:	16 A / AC1	
Breaking capacity:	4000 VA / AC1, 384 W / DC	
Electrical life (AC1):	50 000 operations	
Number of contacts 2 (3):	x	2x chang. / DPDT (AgNi)
Current rating:	x	8 A / AC1
Breaking capacity:	x	2000 VA / AC1, 192 W / DC
Electrical life (AC1):	x	10 000 operations
Switching voltage:	250V AC / 24V DC	
Max. power dissipation:	1.2 W	2.4 W
Output indication:	multifunction red LED	
Mechanical life:	10 000 000 operations	

Control

Control terminals:	A1-S	
Load between S-A2:	Yes	
Impulse length:	min. 25 ms / max. unlimited	
Reset time:	max. 150 ms	

Other information

Operating temperature:	-20 °C to +55 °C (-4 °F to 131 °F)	
Storage temperature:	-30 °C to +70 °C (-22 °F to 158 °F)	
Dielectrical strength:	4kV AC	
supply - output 1	4kV AC	
supply - output 2 (3)	x	1kV AC
output 1 - output 2	x	1kV AC
output 2 - output 3	x	1kV AC
Operating position:	any	
Mounting:	DIN rail EN 60715	
Protection degree:	IP40 from front panel / IP20 terminals	
Overvoltage category:	III.	
Pollution degree:	2	
Max. cable size (mm ²):	solid wire max. 1x 2.5 or 2x 1.5 / with sleeve max. 1x 2.5 (AWG 12)	
Dimensions:	90 x 17.6 x 64 mm (3.5 x 0.7 x 2.5 inch)	
Weight:	62 g (2.2 oz)	85 g (3 oz)

* for adjustable delay <100ms, a time deviation of ± 10ms applies

i. INTERVAL ON / OFF

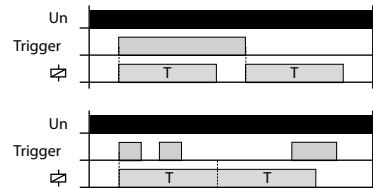

When the supply voltage is applied, the relay is open. When the control contact is closed, the relay closes and the time delay T begins. When the control contact is opened, the relay closes and the time delay T begins. If the control contact is open during timing, the relay remains closed for 2T. When the timing is complete, the relay opens. Any other change of control contact status during timing is ignored.

j. ON / OFF DELAY

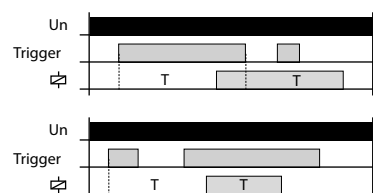

When the supply voltage is applied, the relay is open. If control contact is closed, time delay T starts. When the control contact is opened, a new time delay T begins. If the control contact is open during timing, the relay closes at the end of the timing and opens the relay after the new time delay. Any other change of control contact status during timing is ignored.

More accurate setting of timing for long periods of time

Example of time setting to 8 hours period:
For rough setting use time scale 1-10 s on the potentiometer.
For fine time setting aim for 8 s on potentiometer, then recheck accuracy (using stopwatch etc).
On rough time setting, set potentiometer to originally desired scale 1-10 hours, leave a fine setting as it is.

Warning

Device is constructed for connection in 1-phase AC/DC 12- 240 V main alternating current voltage and must be installed according to norms valid in the state of application. Connection according to the details in this direction. Installation, connection, setting and servicing should be installed by qualified electrician staff only, who has learnt these instruction and functions of the device. This device contains protection against overvoltage peaks and disturbances in supply. For correct function of the protection of this device there must be suitable protections of higher degree (A, B, C) installed in front of them. According to standards elimination of disturbances must be ensured. Before installation the main switch must be in position "OFF" and the device should be de-energized. Don't install the device to sources of excessive electro-magnetic interference. By correct installation ensure ideal air circulation so in case of permanent operation and higher ambient temperature the maximal operating temperature of the device is not exceeded. For installation and setting use screw-driver cca 2 mm. The device is fully-electronic - installation should be carried out according to this fact. Non-problematic function depends also on the way of transportation, storing and handling. In case of any signs of destruction, deformation, non-function or missing part, don't install and claim at your seller it is possible to dismount the device after its lifetime, recycle, or store in protective dump.