



EAN kód
SA3-02M: 8595188132374

Műszaki adatok SA3-02M

Kimenetek

Kimenet:	2x váltóérintkező 16 A/AC1
Kapcsolható feszültség:	250 V AC1, 24 V DC
Kapcsolható teljesítmény:	4000 VA/AC1, 384 W/DC
Túláram:	30 A; max. 4mp, 10% ismétlődésnél
Kimeneti relék elkülönítése a belső áramköröktől:	megerősített szigetelés (II. túlfeszültségi kat., EN 60664-1 szerint)
Szigetelés az RE1 és RE2 relé kimenetek között:	megerősített szigetelés (II. túlfeszültségi kat., EN 60664-1 szerint)
Nyitott relékontaktus szigetelési feszültsége:	1 kV
Minimum kapcsolt áram:	100 mA
Kapcsolási gyakoriság / terhelés nélkül:	1200 min ⁻¹
Kapcsolási gyakoriság / terheléssel:	6 min ⁻¹
Mechanikai élettartam:	3x 10 ⁷
Elektromos élettartam AC1:	0.7x 10 ⁹
Kimenetek jelzése:	2x sárga LED

Kommunikáció

Installációs busz:	BUS
--------------------	-----

Tápellátás

Tápfeszültség / tűrés:	27 V DC, -20 / +10 %
Disszipált teljesítmény:	max. 4 W
Névleges áram:	50 mA (27 V DC-nél), BUS buszról
Állapotjelzés az egységen:	zöld "RUN" LED

Csatlakozások

Sorkapocs:	max. 2.5 mm ² / 1.5 mm ² érvéggel
------------	---

Üzemeltetési feltételek

Levegő páratartalom:	max. 80 %
Működési hőmérséklet:	-20 .. +55 °C
Tárolási hőmérséklet:	-30 .. +70 °C
Védettségi fok:	IP20 eszköz, IP40 kapcsolószekrényben
Túlfeszültségi kategória:	II.
Szennyezettségi fok:	2
Működési helyzet:	tetszőleges
Telepítés:	kapcsolószekrénybe, DIN sínre (EN 60715)
Kivitel:	1-MODUL

Méretetek és tömeg

Méretetek:	90 x 17.6 x 64 mm
Tömeg:	82 g

- Az SA3-02M 2 független relét tartalmaz, potenciál független váltóérintkezőkkel.
- Maximum terhelés kontaktusonként 16 A/4000 VA/AC1.
- Mindkét kimeneti kontaktus külön-külön vezérelhető és címezhető.
- Mindegyik relé váltóérintkezője külön-külön kivezetett csatlakozópontokkal rendelkezik, így az egyes relék különböző potenciálok kapcsolására is alkalmasak (potenciálmentes kontaktusok).
- A potenciálmentes váltóérintkezőknek köszönhetően felhasználható 230 V AC tápfeszültségű kétirányú vezérlések reteszelésére, mint pl. redőnyök, napellenzők. A huzalozott reteszeléssel megakadályozható, hogy egy időben kapjon hálózati feszültséget a mozgató motor két irányvezérlő bemenete.
- Az előlapi LED-ek a kimenetek állapotát jelzik.
- A relék állapota az előlapon található gombokkal külön-külön, kézzel is átkapcsolható.
- Az SA3 kapcsolóegységeknél a kimeneti relék érintkezőinek anyaga az alaptermékben AgSnO₂.
- Az SA3-02M 1-Modulos verzió, kapcsolószekrényben DIN sínre szerelhető (EN60715).

Bekötés

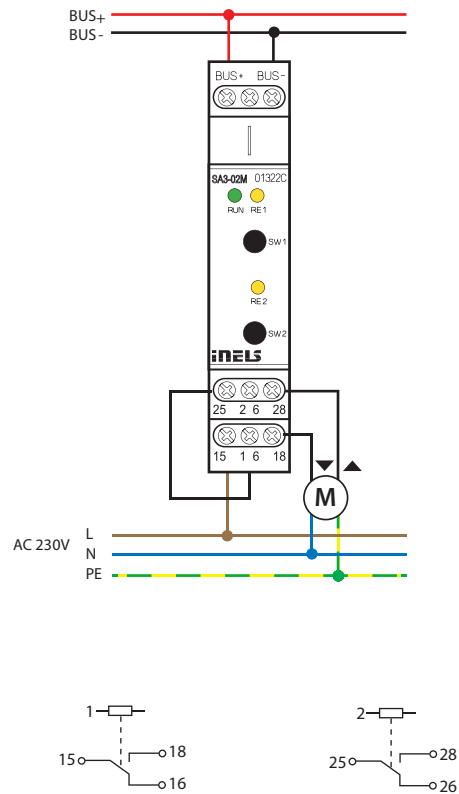

iNELS termékek érintkezőinek terhelhetősége



















Minimális terhelés

Relé érintkező	mV	V/mA
AgSnO ₂	1000	10/100



















Minimális terhelés

Relé érintkező	mV	V/mA
AgNi	300	5/10



















GCR3-11, GCH3-31, GMR3-61, SA3-02B, SA3-06M, SA3-012M, WMR3-21

Terhelés típusa	 $\cos \varphi \geq 0.95$								
Kontaktus anyaga AgSnO ₂ érintkező 8A	AC1 250V / 8A	AC2 250V / 2.5A	AC3 250V / 1.5A	AC5a kompenzálatlan 230V / 1.5A (345VA)	AC5a kompenzált 230V / 1.5A (345VA) till max output C=14uF	AC5b 250W	AC6a 250V / 4A	AC7b 250V / 1A	AC12 250V / 1A
Terhelés típusa									
Kontaktus anyaga AgSnO ₂ érintkező 8A	AC13 x	AC14 250V / 3A	AC15 250V / 3A	DC1 24V / 8A	DC3 24V / 3A	DC5 24V / 2A	DC12 24V / 8A	DC13 24V / 1A	DC14 x



















CU3-04M (RE7 - RE-10), LBC3-02M, SA3-01B, SA3-02M, SA3-04M, SA3-022M (RE7 - RE-10), EA3-022M (RE7 - RE-10), JA3-018M (U/D1 - U/D9)

Terhelés típusa	 $\cos \varphi \geq 0.95$								
Kontaktus anyaga AgSnO ₂ kontakt 16A	AC1 250V / 16A	AC2 250V / 5A	AC3 250V / 3A	AC5a kompenzálatlan 230V / 3A (690VA)	AC5a kompenzált 230V / 3A (690VA) till max output C=14uF	AC5b 1500W	AC6a x	AC7b 250V / 3A	AC12 250V / 10A
Terhelés típusa									
Kontaktus anyaga AgSnO ₂ kontakt 16A	AC13 250 / 6A	AC14 250V / 6A	AC15 250V / 6A	DC1 24V / 16A	DC3 24V / 6A	DC5 24V / 4A	DC12 24V / 16A	DC13 24V / 2A	DC14 24V / 2A





SA3-02B/Ni*, SA3-06M/Ni*, SA3-012M/Ni*

Terhelés típusa	 $\cos \varphi \geq 0.95$								
Kontaktus anyaga AgNi érintkező 8A	AC1 250V / 8A	AC2 250V / 2.5A	AC3 250V / 1.5A	AC5a kompenzálatlan 230V / 1.5A (345VA)	AC5a kompenzált x	AC5b 400W	AC6a x	AC7b 250V / 1.5A	AC12 250V / 5A
Terhelés típusa									
Kontaktus anyaga AgNi érintkező 8A	AC13 250 / 3A	AC14 250V / 3A	AC15 250V / 3A	DC1 24V / 8A	DC3 24V / 3A	DC5 24V / 2A	DC12 24V / 8A	DC13 24V / 1A	DC14 24V / 1A

SA3-01B/Ni*, SA3-06M/Ni*, SA3-04M/Ni*

Terhelés típusa	 $\cos \varphi \geq 0.95$								
Kontaktus anyaga AgNi kontakt 16A	AC1 250V / 16A	AC2 250V / 5A	AC3 250V / 3A	AC5a kompenzálatlan 230V / 3A (690VA)	AC5a kompenzált x	AC5b 800W	AC6a x	AC7b 250V / 3A	AC12 250V / 10A
Terhelés típusa									
Kontaktus anyaga AgNi kontakt 16A	AC13 250 / 6A	AC14 250V / 6A	AC15 250V / 6A	DC1 24V / 16A	DC3 24V / 6A	DC5 24V / 4A	DC12 24V / 16A	DC13 24V / 2A	DC14 24V / 2A

JA3-018M (U/D1 - U/D9),
CU3-04M (RE1 - RE6, OUT1 - OUT2, RE11 - RE16),
SA3-022M (RE1 - RE6, OUT1 - OUT2, RE11 - RE16, SHUTTER),
EA3-022M (RE1 - RE6, OUT1 - OUT2, RE11 - RE16, SHUTTER),
FA3-612M (FAN1 - FAN3, RE)

Terhelés típusa	 $\cos \varphi \geq 0.95$			
Kontaktus anyaga AgNi kontakt 6A	AC1 250V / 6A	AC3 230V / 0.8A	AC15 230V / 1.3A	DC1 30V / 3A 110V / 0.2A 220V / 0.12A

Az információk tájékoztató jellegűek.

* AgNi kontaktussal kizárólag külön megrendelésre és költségre szállítjuk.